

Next-Generation Production Environment Sensors

EQUO Series

OMRON

Air Particle Sensor

ZN-PD-SA

Thermo-Humidity Station

ZN-THX21-SA

Differential Pressure Station

ZN-DPX21-SA



Thermo-Humidity Station

Differential Pressure Station

Air Particle Sensor
Dust measurement type

Air Particle Sensor
Particle measurement type

Make your entire production environment visible

Multi-point monitoring of environmental data and central control

realizing

Four types of vital information to maintain and control clean environments

Temperature & Humidity
Essential data for production environments

Differential Pressure Level
Positive pressure level of clean booth and clean room.

Airborne Particles
Airborne particulates affect the entire clean environment

Generated by people and equipment
Dust Fallout
Dust affects the appearance and quality of the product

By visualizing environmental Why not centrally manage



conditions, it's easier to maintain and control clean environments.
 your measured data to improve quality and save energy?

Precision measurement of temperature and humidity
 along manufacturing lines and around equipment.

Thermo-Humidity Station

ZN-THX21-SA (Station)
 ZN-THS11-S (Sensor head)

-25 to 60°C (Accuracy: ±0.3°C) **0% to 99% (Accuracy: ±2.5%)**

* At 25°C, 10% to 85%

Precision measurement of differential pressure
 between inside and outside of clean room or booth.

Differential Pressure Station

ZN-DPX21-SA (Station)
 ZN-DPS11-S (Sensor head)

-500 to 500 Pa (Accuracy: Within ±3%* of indicated value)

* Zero point accuracy: ±0.2 Pa

Continuously and accurately measures
 airborne particle count.

Air Particle Sensor Particle measurement type

ZN-PD03-SA

0.3 μm

0.5 μm

1.0 μm

Directly measures falling dust that threatens
 product quality.

Air Particle Sensor Dust measurement type

ZN-PD50-SA

5 (10) μm

20 (30) μm

50 μm

Centralized data management through a LAN network.

Easy network connection through Ethernet.
 Centralized management of measured data is
 possible immediately after installation, achieving
 low-cost operation. Also, data can be logged
 automatically at all times, reducing man-hours for
 measurement and labor costs. Easy-to-use GUI
 allows you to visualize the entire clean
 environment.

by PC



→ P11

New Ver.

Clearly visualize multiple types of
 environmental information

Environmental Visualization Software

Wave Inspire ES Option

ZN-SW11-S

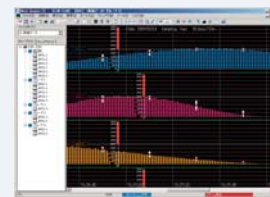

Environmental changes can be tracked
 over time and by distribution

by PLC



Customers can construct their own unique production
 environment monitoring and control systems.

Recommendation: SYSMAC CS/CJ Series Ethernet unit

Note: Some conditions and limitations apply to PLC connection.

Be sure to contact the OMRON Sales Department for details.

Free installation available for any purpose at any Continuous local and multi-point monitoring.



Continuous monitoring of dust generated by machines

Dust measurement type



Continuous monitoring of differential pressure in clean booth

Differential Pressure Station



Continuous monitoring of dust in clean booth

Dust measurement type

Measurement data obtained can help to make all kinds of improve

Example of total manufacturing environment visualization

Quality

Maintains the cleanliness of clean environments with heat-emitting equipment

Problem

The product deficiency caused with the foreign matter is not eliminated though the clean booth is set.

Presence of airborne particles exceeded the designated control value confirmed, but cause unclear

Measurement

Measures airborne particles and differential pressure at the same time!

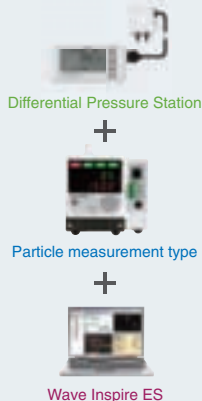

Result

The heat-emitting equipment added to the production site made inside of the booth become a negative pressure.

Correlation between differential pressure level and particle volume revealed!

[Correlation diagram between differential pressure level and particle volume.]

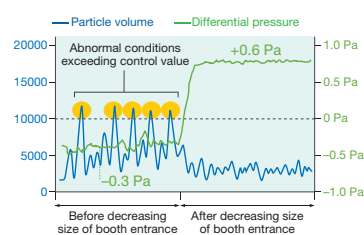

Improvement

Positive pressure restored by modifying the booth entrance

As fluctuations in air intake and outtake are a concern, differential pressure level will be continuously monitored henceforth

Major reduction in particle volume contributes to minimizing product defects

place.



Continuous monitoring of temperature and humidity in clean room

Thermo-Humidity Station



Multi-point monitoring of airborne particles, temperature, and humidity inside clean room

Particle measurement type



Centralized management of production environments

Environmental Visualization Software Wave Inspire ES

ments.

Example of total manufacturing environment visualization

Energy conservation Achieving energy saving through continuous visualization of clean state

Problem

Clean room air conditioners consume an enormous amount of electricity, and should be turned off when facility is not in operation. However, they cannot be turned off due to concerns about product quality.

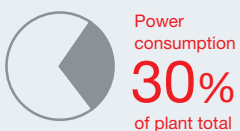

Measurement

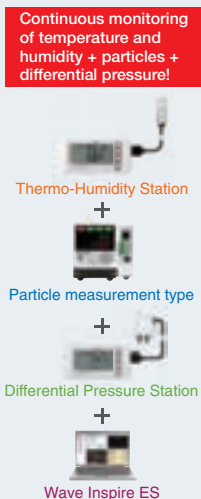

Result

Real-time monitoring of environmental information when air conditioners are operating, stopped, and during unexpected deliveries

[Air conditioning operation status and changes in particle volume]

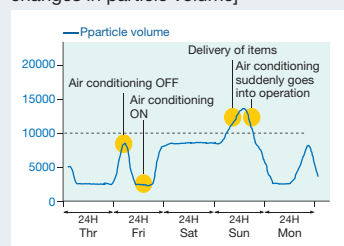

Improvement

Air conditioning is off at night and during holidays when facility is not in operation.

With continuous monitoring of environment, air conditioning can be turned on at the time of need and as much as needed.

Major reduction in electricity consumption of air conditioning

Thermo-Humidity Station

Highly variable

Temperature & Humidity



Precision measurement of temperature and humidity around production lines and equipment.

Thermo-Humidity Station

ZN-THX21-SA (Station)

ZN-THS11-S (Sensor head: 1.5 m type)

-25 to 60°C (Accuracy: ±0.3°C)

0% to 99% (Accuracy: ±2.5%)

ZN-THS17-S (Sensor head: Anchored type)

* At 25°C, 10% to 85%

0 to 60°C (Accuracy: ±0.3°C)

20% to 85% (Accuracy: ±2.5%)

Unparalleled measurement accuracy

Precision measurement ensures a temperature resolution of 0.1°C and humidity accuracy of plus/minus 2.5%. This enables more precise control of temperature and humidity, which contributes to improvement in product quality.

Temperature measurement accuracy

±0.3°C

(at 25°C)

Humidity measurement accuracy

±2.5%

(at 25°C, 10% to 85%)

Temperature resolution

0.1°C

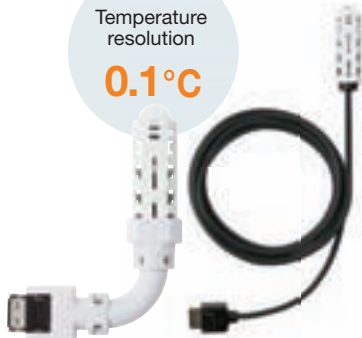

Built-in hybrid logging engine

Data can be logged to the unit (SD Card) while communicating with PC (or PLC) via LAN. Even in the event of network error, the unit will continue to record data. Production technology divisions can centrally control management via network while manufacturing floors can localize control using SD cards.

SD Card slot



Alarm output for immediate response when trouble occurs

The station has an alarm output. Unusual temperature and humidity are made visible, enabling you to make a quick response and to make it easy to systemize manufacturing lines.

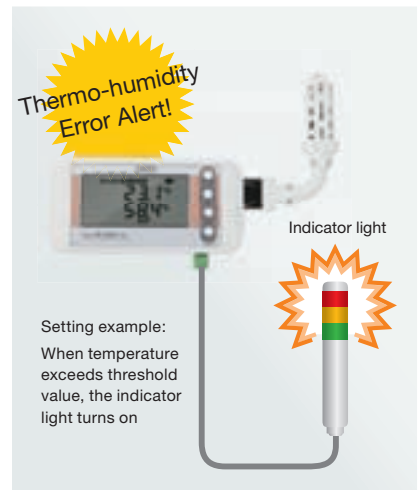

Setting example:
When temperature exceeds threshold value, the indicator light turns on

Temperature and humidity are essential data for quality control on the manufacturing floor. Constantly visualize the changes in temperature and humidity at multiple points.

Big and legible!

Large and easily viewable LCD display with two rows and five characters in each row.



Easy to hang on wall as well

On the reverse side, there are two types of holes; for wall-hanging and for fixing. Magnets are also available (sold separately).



Thermo-Humidity Station is used at the following places...



Heat emission control in various types of processing equipment

Precision measurement contributes to control severe temperature and humidity in the processing equipment.



Temperature and humidity control in data centers

The Station contributes to heat emission control of various types of servers in data centers.

With back-up using commercially available AAA batteries, operation continues even during sudden power outage

With built-in battery backup, LAN communication and logging operation won't stop even in the event of power outage or sudden disconnection.

* In network mode, operation continues for approximately two hours on batteries alone. However, battery life will vary depending on the measurement environment, battery type, or battery performance.



Manganese batteries cannot be used.

Bundled with simple, user-friendly PC software

Simple, user-friendly PC software is included as a standard feature (Station Utility: Setup tool, logging tool, and SD Viewer ES).

Unit setup and data logging are possible via LAN network.

Also, logged data can easily be displayed in the waveform graph.

Setup



Batch setup of multiple units

Logging



Automatic file output at regular intervals

Data display

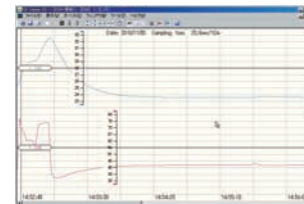

Intermittent data files can be integrated to display in the waveform graph.

To view waveform graphs in real time, and display measured values on a floor plan of the site, it is necessary to install Wave Inspire ES environmental visualization software.

Calibration service also available

A Certificate of Calibration can be issued upon request. (It is necessary to ship the product back to OMRON.) To obtain a Certificate of Calibration at time of purchase, please select a type that includes a Certificate of Calibration.

As the sensor head and station are digitally connected, this calibration service is available only for the sensor head.

* The calibration service does not include repairs or adjustments.



- Calibration Certificate
- Inspection Result
- Traceability Chart

Monitor an invasion of foreign matter

Differential Pressure Level



Precision measurement of differential pressure inside and outside of clean room or booth.

Differential Pressure Station

ZN-DPX21-SA (Station) ZN-DPS11-S (Sensor head: 1.5 m type)
 ZN-DPS15-S (Sensor head: 10 m type)

-500 to 500 Pa (Accuracy: Within $\pm 3\%$ * of indicated value)

* Zero point accuracy: ± 0.2 Pa

Ultra wide-range precision measurement

This ensures a range of minus 500 to plus 500 Pa and differential pressure accuracy of plus/minus 3%. With more accurate differential pressure control, clean room environments can be effectively maintained.

Measurement range

-500 Pa to +500 Pa

Measurement accuracy

Within $\pm 3\%$ * of indicated value

* Zero point accuracy: ± 0.2 Pa



Built-in hybrid logging engine

Data can be logged to the unit (SD Card) while communicating with PC (or PLC) via LAN. Even in the event of network failure, the unit will continue to record data. Production technology divisions can centrally control management via network while manufacturing floors can localize control using SD cards.

SD Card slot



Easily construct a wide range of control systems

Built-in alarm output makes the station an effective part of all kinds of control systems.

- Positive pressure level alert for clean environments
- Automatic control of air conditioning level based on differential pressure level

Alarm output if the differential pressure is less than the standard.

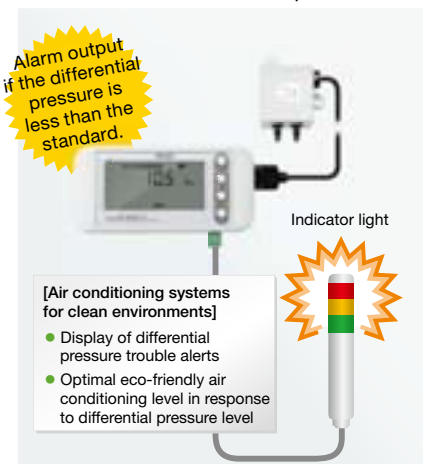

Precision measurement of differential pressure inside and outside of clean room or booth.

Clearly visualize differential pressure shifts at all times.

Big and legible!

Large and easily viewable LCD display with two rows and five characters in each row.



Thermo-Humidity Station is used at the following places...

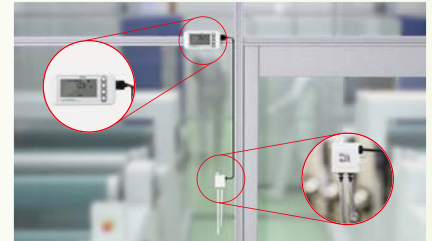

Positive pressure control in large-scale clean booths

Contributes to control of positive pressure due to fluctuations in air intake and outtake in the booth and clogging of FFU filters



Control of differential pressure in air shower rooms

Effective for control of positive pressure level in air shower and interlock control after air shower is finished

Easy to hang on wall as well

On the reverse side, there are two types of holes; for wall-hanging and for fixing. Magnets are also available (sold separately).



Simple visualization software included as a standard.

Simple, user-friendly PC software is included as a standard feature (Station Utility: Setup tool, logging tool, and SD Viewer ES). Unit setup and data logging can be possible via LAN network. Also, logged data can be easily displayed in a waveform graph.

With back-up using commercially available AAA batteries, operation continues even during sudden power outage

With built-in battery backup feature, LAN transmission and logging operation won't stop even in the event of power outage or sudden disconnection.

* In network mode, operation continues for approximately two hours on batteries alone. However, battery life will vary depending on the measurement environment, battery type, or battery performance.



Manganese batteries cannot be used.

Positive pressure level in a clean booth is easily checked using this Differential Pressure Station.

- #### 1 Prepare

Insert a tube into differential pressure sensor head.

Start using immediately upon purchase. Dedicated tube included.
- #### 2 Install

With head mounted outside the booth, the hi-side of the tube is inserted in the booth (positive pressure side).

Compact head size makes it easy to mount and measure at any time.
- #### 3 Measure

Differential pressure levels inside and outside of the booth are displayed.

Simply turn on and start measuring right away.

Calibration service also available

A Certificate of Calibration can be issued upon request. (It is necessary to ship the product back to OMRON.) To obtain a Certificate of Calibration at time of purchase, please select a type that includes a Certificate of Calibration.

As the sensor head and station are digitally connected, this calibration service is available only for the sensor head.

* The calibration service does not include repairs or adjustments.



- Calibration Certificate
- Inspection Result
- Traceability Chart

Air Particle Sensor

Airborne Particles



Continuously and accurately measures airborne particles.

Air Particle Sensor

Particle measurement type

ZN-PD03-SA

0.3 µm

0.5 µm

1.0 µm

Dust Fallout

generated by human body and equipment



Directly measures falling dust that threatens product quality.

Air Particle Sensor

Dust measurement type

ZN-PD50-SA

5 (10) µm

20 (30) µm

50 µm

Particle measurement type

Highly accurate measurement comparable to particle counters

A high power suction fan and the internal structure designed to rectify airflow ensure a suction rate of 2.83 l/min.* Accuracy is close to purpose-specific particle counters thanks to laser optics design technology that Omron has cultivated with high precision displacement sensors.



Particles are counted by irradiating the incoming airflow with a laser and detecting the scattering light from the particles.

* Suction rate detected by particle measuring sensor. Suction rate for dust measuring sensors is 6.0 l/min.

Dust measurement type

One unit for measuring dust fallout and identifying dust sources

Funnel-shaped intake and powerful suction fan efficiently capture falling dust. Large diameter dust is trapped by a built-in filter. Moreover, trapped dust can be collected using two-sided tape attached inside of the pull-out trap box. The dust can then be analyzed under microscope to identify the source.



Easily detachable filter

Trap box

* The larger the size, the more dust it traps. Some types of dust may penetrate the trap box.

Compact design and reduced maintenance costs

The Sensor is small enough to fit in the palm of your hand, which makes it easy to mount on a wall or other convenient locations. Maintenance costs are also reduced because the product does not use an external pump that would normally require frequent replacement.



Compact size

Dust fallout and airborne particles detract from product quality. Continuously monitor these two factors to minimize their effects.

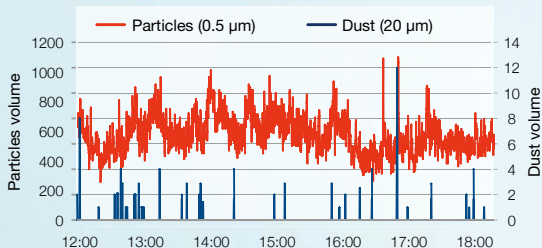

Airborne particles and dust fallout are not correlated due to differences in their behavior. Therefore, it is necessary to measure both of them separately and accurately. Putting the particle type on the wall of the room, and the dust type in the vicinity of product processing equipment, is recommended.

Thermo-Humidity Station is used at the following places...



Dust control for secondary battery manufacturing equipment (Dust)



Clean room management in FPD plant (Particles)



Monitoring sources of foreign substance in automobile painting process (microparticles)

* It cannot be used in explosion-proof painting booths.

Simply turn on and start measuring right away.



Installation is easy since it can be mounted to DIN rail. You can measure anywhere.

Adjustment of particle diameter setting is simple

Wide range of interfaces allow for extension

Inputs and outputs include trigger input, alarm output x 2, and error output, which can be used for a variety of purposes including dust level setting, alarm output, timed measurement, and so forth.



Input/Output terminals

Trigger input
Alarm output x 2
Error output

Triggers can be input to initiate monitoring when necessary and alarms can be output at desired control levels.

Integrated airborne particle sensor and thermo-humidity sensor also available. Achieve your ideal temperature and humidity measurement.

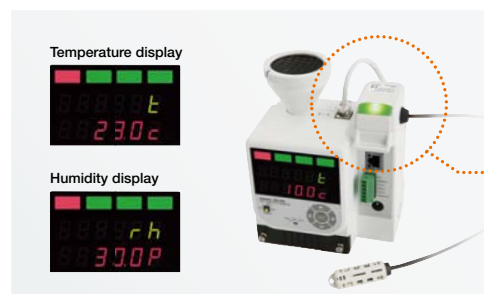

Temperature, humidity and simple dew point can be easily displayed when connected to an Air Particle Sensor*. And, the unit delivers the highest class of sensing performance. You will benefit from wide measurement ranges and highly accurate humidity measuring.

Air Thermo Sensor Temperature and humidity measurement type

ZN-TH11-S

Temperature Humidity Simple dew point

* There are limitations on the particle sensors that can be connected to the Air Thermo Sensor. Please refer to the "Specifications / Performance" information.
The dew point can be handily calculated by using the measured values for temperature and humidity.

Calibration service also available

A Certificate of Calibration can be issued upon request. (It is necessary to ship the product back to OMRON.) To obtain a Certificate of Calibration at time of purchase, please select a type that includes a Certificate of Calibration.

* The calibration service does not include repairs or adjustments.



- Calibration Certificate
- Inspection Result
- Traceability Chart

Centralized management of environmental information using software visualizing the workplace environment. Find solutions to workplace problems by verifying data trends.

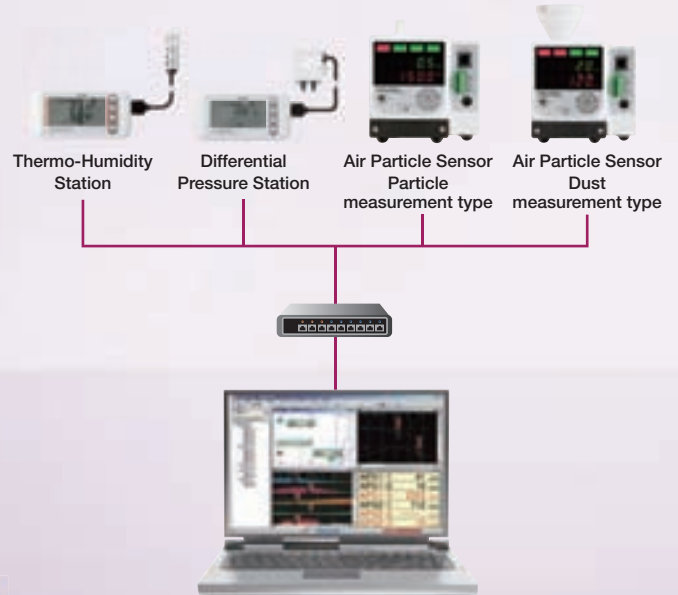
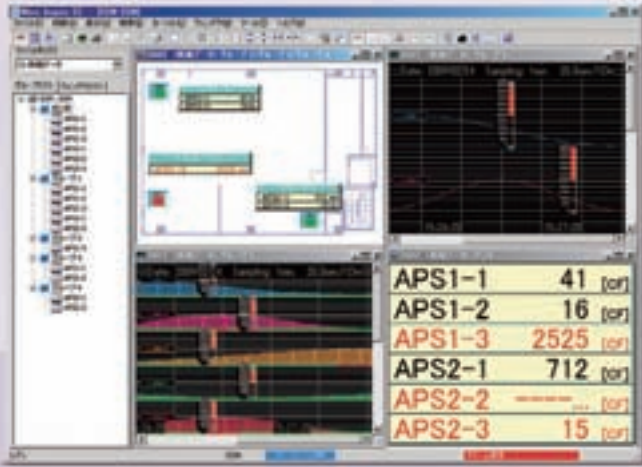

Centralized management of measured data

OPTION Environmental Visualization Software

Wave Inspire ES

ZN-SW11-S

Centralized management of manufacturing floor environmental information

Diverse data measured by sensors and stations can be logged collectively. Measurement data can be viewed as a list, or measured values can be digitally represented on a map.

- Scale setting for each measured factor
- Display of maximums, minimums and averages
- Simultaneously viewing of multiple windows
- Alarm judgment display
- CSV output
- Microsoft Excel transfer function

Real-time analysis of measured data

Trends by location, time and date are available at a glance. The maximum, minimum and average number of particles in a set period of time can also be displayed.

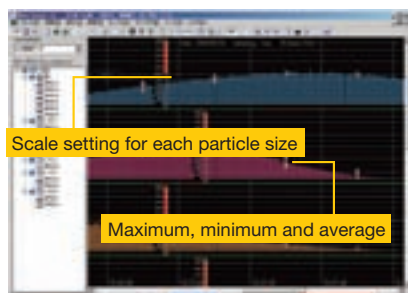

Mapping of sensor locations and measurement results

An alarm will sound when levels exceed the set control values. The spot where the trouble has occurred can be identified by a quick glance.

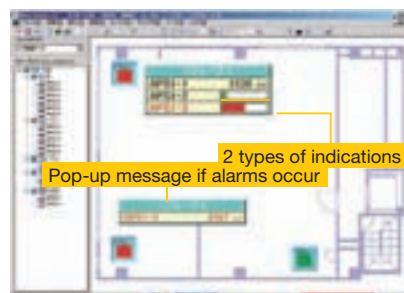

Selected data transferred to Excel

The necessary data items can be selected from amongst large volumes of logged data to convert to Excel-readable CSV files.

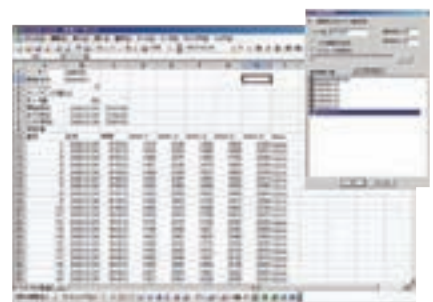

* The number of sensors that you can connect to the ZN-SW11-S Environmental Visualization Software will depend on your operating conditions.

Specifications Thermo-Humidity Station

Ordering Information

Main unit

Appearance	Item	Model
	Sensor head 1.5 m type	ZN-THS11-S
		ZN-THS11C-S*
	Sensor head Anchored type	ZN-THS17-S
		ZN-THS17C-S*
	Station	ZN-THX21-SA

* Please choose this form when you buy with the calibration certificate.
Contents of Certificate of Calibration Set: Calibration Certificate, Inspection Result, and Traceability Chart

Accessories (Order separately)

Appearance	Item	Model	
	Mounting Magnet *1	ZN9-EM01-S	
	DC cable (2 m) (ZN9-ED01-S comes with ZN-THX21-SA)	Straight type	ZN9-ED01-S
		Right angle type	ZN9-ED02-S
	AC Adaptor for ZN-□□X-SA Power supply voltage: 100 to 240 VAC/50 to 60 Hz Operating temperature range: 0 to 40°C	PSE, CE, UL STD/ A-type plug	ZN9-ACP01-S
	Environmental Visualization Software Wave Inspire ES *2,*3,*4		ZN-SW11-S

- *1 When the magnet is used, the vibration resistance becomes 55 Hz or less. (Two logger installation screws are attached.)
- *2 System requirements OS: Windows XP / Windows Vista / Windows 7 (64 Bit not supported)
CPU: compatible Intel processors, 1 GHz or higher. Memory: 1 GB or more (2 GB or more recommended)
- *3 The compliant version is Ver2.1.0 or later
- *4 The maximum number of connectable sensors is 95.
(When one PC is connected with a leased line network, the sampling period is set to 10 minutes.)
The number of possible sensor connections changes by a sampling period, connected number of PC or PLC, and the network load situation.

Calibration service

Subject to calibration	Content	Model
Sensor head 1.5 m type	Calibration Certificate, Inspection Result Traceability chart	ZN-THS11-CAL
Sensor head Anchored type	Calibration Certificate, Inspection Result Traceability chart	ZN-THS17-CAL

- * If a Certificate of Calibration is required after you purchase the sensor head, use the above model number to order one.
- * As the sensor head and station are digitally connected, only the sensor head is subject to calibration.
- * It is necessary to ship the product back to OMRON in Japan.
- * The calibration service does not include repairs or adjustments.

External Dimensions Tolerance class IT16 applies to the dimensions unless otherwise specified.

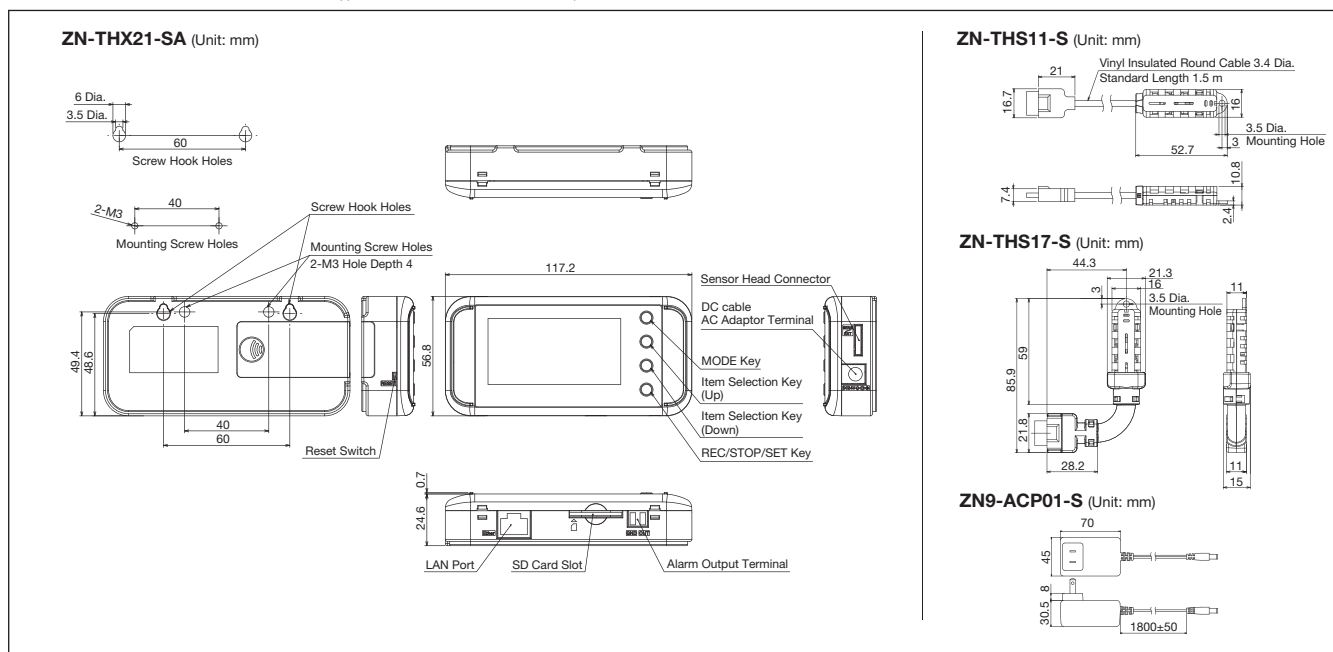

Specifications

Sensor head

Item	Model	ZN-THS 11-S (Sensor head: 1.5 m type)	ZN-THS 17-S (Sensor head: Anchored type)
Temperature	Measurement range	-25 to +60°C	0 to 60°C
	Measurement precision	±0.3°C (at 25°C)	
	Resolution	0.1°C	
Relative humidity	Zero point	0% to 99%	20% to 85%
	Span	±2.5% (at 25°C, 10 to 85%)	
	Resolution	0.1%	
Weight (packaged)	Approx. 300 g		
Accessories	Instruction sheet Mounting screw (M3 x 8) x 1	Instruction sheet Mounting screw (M3 x 8) x 1 Caps to secure cable	

- * As performance may deteriorate through the adhesion of impurities or contaminants in the environment on the sensor surface, calibration is recommended once a year.
- * When ZN-THS1□□-S is exposed over a long period of time at a high humidity of 80% or higher, the humidity measurement value may be offset.
In that case, expose the product at room temperature and humidity for 24 hours prior to use.
- * When ZN-THS1□□-S is transferred rapidly between the places where temperature difference is large, condensation may occur on the sensor surface.
In that case, the ZN-THS1□□-S may not work properly.
When the product becomes wet due to condensation, allow the product to dry in dry, room temperature environment before use.
- * When using the ZN-THS1□□-S under conditions with temperature of -20°C or less or with humidity of 90% or more, acceleration of sensor deterioration may occur.
- * To avoid deterioration of sensor, avoid storing the product under high temperature and high humidity for a long period of time.
- * Please don't use the product in the environment to which organic chemistry material disperses.

Station

Item	Model	ZN-THX21-SA
Sensor that can be connected	Thermo-Humidity Sensor Head (ZN-THS□□-S)	
Display	LCD 7-segment 5-digit 2-step display, auxiliary information indicator display	
Measurement interval	10 s, 20 s, 30 s, 1 min, 2 min, 5 min, 10 min, 20 min, 30 min, 1 h	
Calculation function	Instantaneous value, maximum value, minimum value, average value	
Operating mode	Network connection mode, sleep mode *1 air particle sensor (ZN-PD□□-S) connection mode *2	
Recording mode	Continue *3, ring *4	
Alarm signal output	Output to photocoupler (External power supply: 12 to 24 VDC, Load current: Max. 45 mA) Alarm hold setting is possible. *5	
Communications interface	Ethernet (10BASE-T, 100BASE-TX)	
Communications protocol	Socket (TCP), original protocol	
Internal storage device	Internal memory: Approx. 8,500 data items *6	
External storage device	SD card (to save measured values and to save/read set values), Recommended SD card: HMC-SD291 (manufactured by OMRON) *7	
Power supply voltage	DC input: 24 VDC ±10% Battery: 2 AAA batteries *8	
Battery life *9	Approx. 1 year *9 (sleep mode) Approx. 2 hours *9 (Network connection mode, air particle sensor (ZN-PD□□-S) connection mode) Measurement interval of 10 minutes (with 2 AAA nickel metal hydride batteries, with SD card not inserted)	
Operating temperature range	0 to 60°C	
Operating humidity range	20% to 85% (no condensation)	
Weight (packaged)	Approx. 500 g	
Accessories	Instruction Sheet, Startup Guide, DC cable (straight type), Ferrite core, CD-ROM *10, Alarm output connector *11	

- *1 Power saving mode. The indicator is always OFF in default setting. (Turns ON with button operation.)
Network communications with host devices cannot be made.
- *2 This mode makes one-to-one network connection with Air Particle Sensor (ZN-PD□□-S) and enables logging of the particle count value and thermal data simultaneously to the SD card.
Network communications with host devices cannot be made.
- *3 Automatically writes data to the SD card when reaching the upper limit of the internal memory and keeps recording until the capacity limit of the SD card. If the SD card is not inserted when the internal memory reaches the upper limit, recording stops. (Data can be output to the SD card by pressing the button after inserting the SD card.)
- *4 This mode always records the latest measured values for the upper limit of the internal memory. (When the measured values exceed the upper limit of the internal memory, the data items will be deleted beginning with the oldest data item.)
- *5 An alarm is shown when exceeding the upper limit value or lower limit value that has been set in threshold setting mode.
- *6 Air particle sensor connection mode is excluded.
- *7 If you use an SD or SDHC card from another manufacturer, you will be able to temporarily read and write data. However, it may become impossible to recognize some cards during operation, and data may be lost. Please use the recommended SD card.
- *8 Nickel hydride battery and alkaline battery can be used. Manganese batteries cannot be used.
- *9 Battery life differs depending on measurement environment, sampling, operating mode, battery type or performance.
- *10 System Requirements for Enclosed PC Software (Station Utility: Setup Tool, Logging Tool, and SD Viewer ES)
OS: Windows XP / Windows Vista / Windows 7 (64 Bit not supported)
CPU: compatible Intel processors, 1 GHz or higher.
Memory: 1 GB or more (2 GB or more recommended)
- *11 The connector is type XW4B-02B1-H1, made by OMRON.

Specifications Differential Pressure Station

Ordering Information

Main unit

Appearance	Item	Model
	Sensor head 1.5 m type	ZN-DPS11-S ZN-DPS11C-S*
	Sensor head 10 m type	ZN-DPS15-S ZN-DPS15C-S*
	Station	ZN-DPX21-SA

* Please choose this form when you buy with the calibration certificate.
Contents of Certificate of Calibration Set: Calibration Certificate, Inspection Result, and Traceability Chart

Accessories (Order separately)

Appearance	Item	Model	
	Mounting Magnet *1	ZN9-EM01-S	
	DC cable (2 m) (ZN9-ED01-S comes with ZN-DPX21-SA)	Straight type	ZN9-ED01-S
		Right angle type	ZN9-ED02-S
	AC Adaptor for ZN-□□X-SA Power supply voltage: 100 to 240 VAC/50 to 60 Hz Operating temperature range: 0 to 40°C	PSE, CE, UL STD/ A-type plug	ZN9-ACP01-S
	Environmental Visualization Software Wave Inspire ES *2 *3 *4		ZN-SW11-S

*1 When the magnet is used, the vibration resistance becomes 55 Hz or less. (Two logger installation screws are attached.)

*2 System requirements OS: Windows XP / Windows Vista / Windows 7 (64 Bit not supported)
CPU: compatible Intel processors, 1 GHz or higher. Memory: 1 GB or more (2 GB or more recommended)

*3 The compliant version is Ver2.1.0 or more

*4 The maximum number of connectable sensors is 95.
(When one PC is connected with a leased line network. The sampling period is set to 10 minutes.)
The number of possible sensor connections changes by a sampling period, connected number of PC or PLC, and the network load situation.

Calibration service

Subject to calibration	Content	Model
Sensor head 1.5 m type	Calibration Certificate, Inspection Result Traceability chart	ZN-DPS11-CAL
Sensor head 10 m type	Calibration Certificate, Inspection Result Traceability chart	ZN-DPS15-CAL

- If a Certificate of Calibration is required after you purchase the sensor head, use the above model number to order one.
- As the sensor head and station are digitally connected, only the sensor head is subject to calibration. Remove the tube.
- It is necessary to ship the product back to OMRON in Japan.
- The calibration service does not include repairs or adjustments.

Specifications

Sensor head

Item	Type	ZN-DPS11-S	ZN-DPS15-S
Differential pressure	Measurement range	-500 to 500 Pa	
	Measurement precision	3%±0.2 Pa of the measured value (at 23°C, 966 mbar)*	
	Resolution	0.1 Pa	
Temperature effect	Zero point	No effects (lower than measurement resolution)	
	Span	Less than 0.5% of the specified value/10°C	
Operating temperature range		0 to 50°C	
Applicable gas type		Air, nitrogen	
Cable length		1.5 m	10 m
Weight (packaged)		Approx. 500 g	
Accessories		Instruction Sheet, air tube 1 m x 2, mounting screw (M3 x 6) x 2	

- * For the precision under a rated environment, an offset less than 0.1 Pa/year may occur.
- * The accessories tube inside diameter is 4 mm, and the outside diameter is 6 mm.

Station

Item	Model	ZN-DPX21-SA
Sensor that can be connected		Fine differential pressure sensor head (ZN-DPS1□□-S)
Display		LCD 7-segment 5-digit 2-step display, auxiliary information indicator display
Measurement interval		10 s, 20 s, 30 s, 1 min, 2 min, 5 min, 10 min, 20 min, 30 min, 1 h
Calculation function		Instantaneous value, maximum value, minimum value, average value
Operating mode		Network connection mode, sleep mode *1 air particle sensor (ZN-PD□□-S□) connection mode *2
Recording mode		Continue *3, ring *4
Alarm signal output		Output to photocoupler (External power supply: 12 to 24 VDC, Load current: Max. 45 mA) Alarm hold setting is possible. *5
Communications interface		Ethernet (10BASE-T, 100BASE-TX)
Communications protocol		Socket (TCP), original protocol
Internal storage device		Internal memory: Approx. 8,500 data items *6
External storage device		SD card (to save measured values and to save/read set values), Recommended SD card: HMC-SD291 (manufactured by OMRON) *7
Power supply voltage		DC input: 24 VDC±10% Battery: 2 AAA batteries *8
Battery life *9		Approx. 1 year *9 (sleep mode) Approx. 2 hours *9 (Network connection mode, air particle sensor (ZN-PD□□-S□) connection mode) Measurement interval of 10 minutes with 2 AAA nickel metal hydride batteries, with SD card not inserted)
Operating temperature range		0 to 60°C
Operating humidity range		20% to 85% (no condensation)
Weight (packaged)		Approx. 500 g
Accessories		Instruction Sheet, Startup Guide CD-ROM *10, DC cable (straight type), Ferrite core, Alarm output connector *11

- *1 Power saving mode. The indicator is always OFF in default setting. (Turns ON with button operation.) Network communications with host devices cannot be made.
- *2 This mode makes a one-to-one network connection with Air Particle Sensor (ZN-PD□□-S□) and enables logging of the particle count value and differential pressure data simultaneously to the SD card. Network communications with host devices cannot be made.
- *3 Automatically writes data to the SD card when reaching the upper limit of the internal memory and keeps recording until the capacity limit of the SD card. If the SD card is not inserted when the internal memory reaches the upper limit, recording stops. (Data can be output to the SD card by pressing the button after inserting the SD card.)
- *4 This mode always records the latest measured values for the upper limit of the internal memory. (When the measured values exceed the upper limit of the internal memory, the data items will be deleted beginning with the oldest data item.)
- *5 An alarm is shown when exceeding the upper limit value or lower limit value that has been set in threshold setting mode.
- *6 Air particle sensor connection mode is excluded.
- *7 If you use an SD or SDHC card from another manufacturer, you will be able to temporarily read and write data. However, it may become impossible to recognize some cards during operation, and data may be lost. Please use the recommended SD card.
- *8 Nickel hydride battery and alkaline battery can be used. Manganese batteries cannot be used.
- *9 Battery life differs depending on measurement environment, sampling, operating mode, battery type, or performance.
- *10 System Requirements for Enclosed PC Software (Station Utility: Setup Tool, Logging Tool, and SD Viewer ES)
OS: Windows XP / Windows Vista / Windows 7 (64 Bit not supported)
CPU: compatible Intel processors, 1 GHz or more.
Memory: 1 GB or more (2 GB or more recommended)
- *11 The connector is type XW4B-02B1-H1, made by OMRON.

External Dimensions Tolerance class IT16 applies to the dimensions unless otherwise specified.

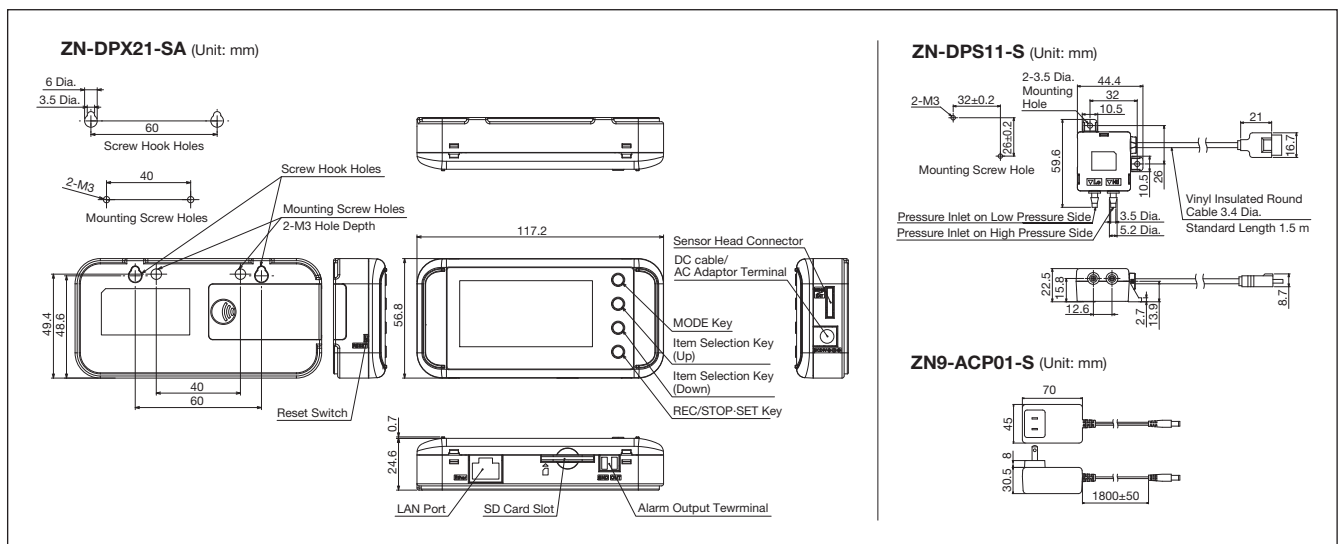

Specifications **Air Particle Sensor**

Ordering Information

■ Sensor

Appearance	Item (Measured particle diameter)	Model
	Air Particle Sensor Particulate measurement type 0.3, 0.5, or 1.0 µm min.	ZN-PD03-SA ZN-PD03C-SA*
	Air Particle Sensor Dust measurement type 5 µm (10 µm), 20 µm (30 µm), 50 µm min.	ZN-PD50-SA ZN-PD50C-SA*
	Air Thermo Sensor For temperature / humidity measurement	ZN-TH11-S

* Please choose this form when you buy with the calibration certificate.
Contents of Certificate of Calibration Set: Calibration Certificate, Inspection Result, and Traceability Chart

■ Accessories (Order separately)

<Air Particle Sensor>

Shape	Item (Applicable Standards)	Rated Voltage	Model
	AC adaptor (PSE)	100 to 125 VAC	ZN9-ACP02-PSE
	AC adaptor (CCC)	100 to 240 VAC	ZN9-ACP02-CCC
	AC adaptor (KC)	100 to 240 VAC	ZN9-ACP02-KC
	AC adaptor (CE)	100 to 240 VAC	ZN9-ACP02-CE
	AC adaptor (UL)	100 to 125 VAC	ZN9-ACP02-UL

Appearance	Item	Model	
	Change filter set for Particulate measurement type	ZN9-PF1-S	
	Change filter set for Dust measurement type	ZN9-PF2-S	
	Change funnel for Dust measurement type	ZN9-PG1-S	
	Exhaust tube (4 m)	ZN9-PT4-S	
	Exhaust tube (8 m)	ZN9-PT8-S	
	Filter for cleaning	ZN9-PC1-S	
	DC cable (2 m) (ZN9-ED02-S comes with ZN-PD□□-SA)	Straight type	ZN9-ED01-S
		Right angle type	ZN9-ED02-S

<Air Thermo Sensor>

Appearance	Item	Model
	Connection cable for air particle sensor (With RJ-45 connectors at both ends, length: 0.1 m)	ZN9-TL01-S
	Connection cable for air particle sensor (With RJ-45 connectors at both ends, length: 2 m)	ZN9-TL20-S
	Connection cable for external device (With a RJ-45 connector at one end, length: 2 m)	ZN9-TC20-S

■ PC Software

Appearance	Item	Model
	Wave Inspire ES	ZN-SW11-S

* System requirements OS: Windows XP / Windows Vista / Windows 7 (64 Bit not supported)
CPU: compatible Intel processors, 1 GHz or higher.
Memory: 1 GB or more (2 GB or more recommended)
The maximum number of connectable sensors is 95.
(When one PC is connected with a leased line network . The sampling period is set to 10 minutes.)
The number of possible sensor connections changes by a sampling period, connected number of PC or PLC, and the network load situation.

Specifications

■ Air Particle Sensor

Item	Particle measurement type (ZN-PD03-SA)	Dust measurement type (ZN-PD50-SA)
Measurement method	90° sideways light-scattering method	
Light source	Semiconductor laser	
Measured particle diameter	0.3, 0.5, or 1.0 µm min.	5 µm (10 µm), 20µm (30 µm), 50 µm min. *1
Particle concentration	0 to 100,000 particles / cf	0 to 50,000 particles/cf
Sample flow rate	More than 2.8 Liter/min	More than 6.0 Liter/min
Status outputs (2 outputs)	Photocoupler output (Status outputs linked with clean levels)	
System error status output	Photocoupler input	
Trigger Input	Photocoupler input	
Communications interface	Ethernet (10BASE-T, 100BASE-TX)	
Communications protocol	Socket (TCP), original protocol	
Indicators	Clean Level: 4 steps display according to clean level (adjustable) 7-segment main display (red); Measurement value (For particle count, the three type displays are selectable; particles/cf, particles/liter and particles/measurement time With ZN-TH11-S; temperature, humidity and dew point) 7-segment sub-display (green): Threshold particle diameter, With ZN-TH11-S; t (temperature), rh (humidity), dp (dew point)	
Measure Mode	Real-time mode (by second) / Cycle mode (by set cycle) / Trigger mode (by trigger)	
Power supply voltage	DC 18 V – 25 V AC Adaptor: 100 to 240 V / 50 to 60 Hz *2	
Current consumption	1A MAX	
Ambient temperature range	Operating: 0 to 35°C	Operating: 0 to 40°C
	Storage: -15 to 50 (with no icing or condensation)	
Ambient humidity range	Operating and storage: 35% to 85% (with no icing or condensation)	
Insulation resistance	20 MΩ min. at 500 VDC	
Withstand voltage	1,000 VAC, 50/60 Hz for 1 min	
Vibration resistance	110 to 55 Hz, 0.3 mm double amplitude, 50 min	
Materials	ABS	
Degree of protection	IP20	
Installation method	DIN track mount / Self standing	
Weight (Packed state)	Approx. 1.7 kg	
Accessories	Instruction Sheet, DC cable	
	Air-intake tube (Tubing ID: 10 dia., Length 1 m) x1	Air filter x1 Funnel x1

*1 () is selectable.
*2 AC adaptor is not bundled.

■ Air Thermo Sensor

Item	ZN-TH11-S	
Supply voltage	12 to 24 VDC ±10% Ripple (p-p): 10% max.	
Current consumption	40 mA max.	
Temperature	Range	-25 to 60°C
	Measurement accuracy	±0.3°C (at 25°C)
Humidity	Resolution	0.1°C
	Range	0% to 99%
Humidity	Measurement accuracy	±2.5% (at 25°C, 10% to 85%)
	Resolution	0.1%
Indicator	Alarm LED on the body	
Alarm threshold	Threshold can be set for temperature, humidity or dew point.	
Data update cycle	10 s	

• Connection cable (Type ZN9-TL□□) is needed to connect with ZN-PD-S.
• After ZN-TH11-S is kept in high humidity environment (more than 80%) for a long time, humidity measurement values might shift (approx +3% with 60 hrs).
In that case, the ZN-TH11-S needs to be kept in room temperature and humidity for more than 1 day.

Calibration service

Subject to calibration	Content	Model
Air Particle Sensor Particulate measurement type	Calibration Certificate, Inspection Result Traceability chart	ZN9-PD03C-S
Air Particle Sensor Dust measurement type	Calibration Certificate, Inspection Result Traceability chart	ZN9-PD50C-S
Air Thermo Sensor	Calibration Certificate, Inspection Result Traceability chart	ZN9-TH11C-S

* If a Certificate of Calibration is required after you purchase the sensor head, use the above model number to order one.
* It is necessary to ship the product back to OMRON in Japan.
* The calibration service does not include repairs or adjustments.

External Dimensions Tolerance class IT16 applies to the dimensions unless otherwise specified.

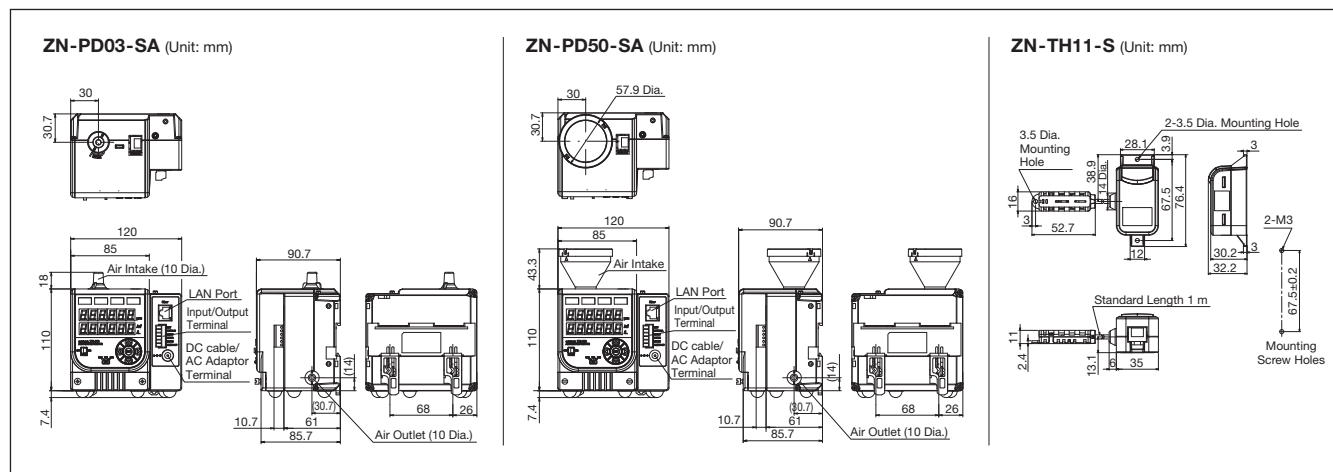

Read and Understand this Catalog

Please read and understand this catalog before purchasing the product. Please consult your OMRON representative if you have any questions or comments.

Warranty and Limitations of Liability

WARRANTY

OMRON's exclusive warranty is that the products are free from defects in materials and workmanship for a period of one year (or other period if specified) from date of sale by OMRON.

OMRON MAKES NO WARRANTY OR REPRESENTATION, EXPRESS OR IMPLIED, REGARDING NON-INFRINGEMENT, MERCHANTABILITY, OR FITNESS FOR PARTICULAR PURPOSE OF THE PRODUCTS. ANY BUYER OR USER ACKNOWLEDGES THAT THE BUYER OR USER ALONE HAS DETERMINED THAT THE PRODUCTS WILL SUITABLY MEET THE REQUIREMENTS OF THEIR INTENDED USE. OMRON DISCLAIMS ALL OTHER WARRANTIES, EXPRESS OR IMPLIED.

LIMITATIONS OF LIABILITY

OMRON SHALL NOT BE RESPONSIBLE FOR SPECIAL, INDIRECT, OR CONSEQUENTIAL DAMAGES, LOSS OF PROFITS OR COMMERCIAL LOSS IN ANY WAY CONNECTED WITH THE PRODUCTS, WHETHER SUCH CLAIM IS BASED ON CONTRACT, WARRANTY, NEGLIGENCE, OR STRICT LIABILITY.

In no event shall the responsibility of OMRON for any act exceed the individual price of the product on which liability is asserted.

IN NO EVENT SHALL OMRON BE RESPONSIBLE FOR WARRANTY, REPAIR, OR OTHER CLAIMS REGARDING THE PRODUCTS UNLESS OMRON'S ANALYSIS CONFIRMS THAT THE PRODUCTS WERE PROPERLY HANDLED, STORED, INSTALLED, AND MAINTAINED AND NOT SUBJECT TO CONTAMINATION, ABUSE, MISUSE, OR INAPPROPRIATE MODIFICATION OR REPAIR.

Application Considerations

SUITABILITY FOR USE

OMRON shall not be responsible for conformity with any standards, codes, or regulations that apply to the combination of products in the customer's application or use of the products.

At the customer's request, OMRON will provide applicable third party certification documents identifying ratings and limitations of use that apply to the products. This information by itself is not sufficient for a complete determination of the suitability of the products in combination with the end product, machine, system, or other application or use.

The following are some examples of applications for which particular attention must be given. This is not intended to be an exhaustive list of all possible uses of the products, nor is it intended to imply that the uses listed may be suitable for the products:

- Outdoor use, uses involving potential chemical contamination or electrical interference, or conditions or uses not described in this catalog.

- Nuclear energy control systems, combustion systems, railroad systems, aviation systems, medical equipment, amusement machines, vehicles, safety equipment, and installations subject to separate industry or government regulations.
- Systems, machines, and equipment that could present a risk to life or property.

Please know and observe all prohibitions of use applicable to the products.

NEVER USE THE PRODUCTS FOR AN APPLICATION INVOLVING SERIOUS RISK TO LIFE OR PROPERTY WITHOUT ENSURING THAT THE SYSTEM AS A WHOLE HAS BEEN DESIGNED TO ADDRESS THE RISKS, AND THAT THE OMRON PRODUCTS ARE PROPERLY RATED AND INSTALLED FOR THE INTENDED USE WITHIN THE OVERALL EQUIPMENT OR SYSTEM.

PROGRAMMABLE PRODUCTS

OMRON shall not be responsible for the user's programming of a programmable product, or any consequence thereof.

Disclaimers

CHANGE IN SPECIFICATIONS

Product specifications and accessories may be changed at any time based on improvements and other reasons.

It is our practice to change model numbers when published ratings or features are changed, or when significant construction changes are made. However, some specifications of the products may be changed without any notice. When in doubt, special model numbers may be assigned to fix or establish key specifications for your application on your request. Please consult with your OMRON representative at any time to confirm actual specifications of purchased products.

DIMENSIONS AND WEIGHTS

Dimensions and weights are nominal and are not to be used for manufacturing purposes, even when tolerances are shown.

PERFORMANCE DATA

Performance data given in this catalog is provided as a guide for the user in determining suitability and does not constitute a warranty. It may represent the result of OMRON's test conditions, and the users must correlate it to actual application requirements. Actual performance is subject to the OMRON Warranty and Limitations of Liability.

ERRORS AND OMISSIONS

The information in this document has been carefully checked and is believed to be accurate; however, no responsibility is assumed for clerical, typographical, or proofreading errors, or omissions.

* EQUO is trademark of OMRON Corporation in Japan and other countries.

* Microsoft and Windows are registered trademarks of Microsoft Corporation in the United States and other countries.

OMRON Corporation Industrial Automation Company
Tokyo, JAPAN

Contact: www.ia.omron.com

Regional Headquarters

OMRON EUROPE B.V.

Sensor Business Unit

Carl-Benz-Str. 4, D-71154 Nufringen, Germany
Tel: (49) 7032-811-0/Fax: (49) 7032-811-199

OMRON ASIA PACIFIC PTE. LTD.

No. 438A Alexandra Road # 05-05/08 (Lobby 2),
Alexandra Technopark,
Singapore 119967
Tel: (65) 6835-3011/Fax: (65) 6835-2711

OMRON ELECTRONICS LLC

One Commerce Drive Schaumburg,
IL 60173-5302 U.S.A.
Tel: (1) 847-843-7900/Fax: (1) 847-843-7787

OMRON (CHINA) CO., LTD.

Room 2211, Bank of China Tower,
200 Yin Cheng Zhong Road,
PuDong New Area, Shanghai, 200120, China
Tel: (86) 21-5037-2222/Fax: (86) 21-5037-2200

Authorized Distributor:

© OMRON Corporation 2011 All Rights Reserved.
In the interest of product improvement,
specifications are subject to change without notice.

CSM_8_1_1015
Cat. No. E411-E1-02

Printed in Japan
0513 (0611) (TA)