

E3X-DAC-S

Operation Reference

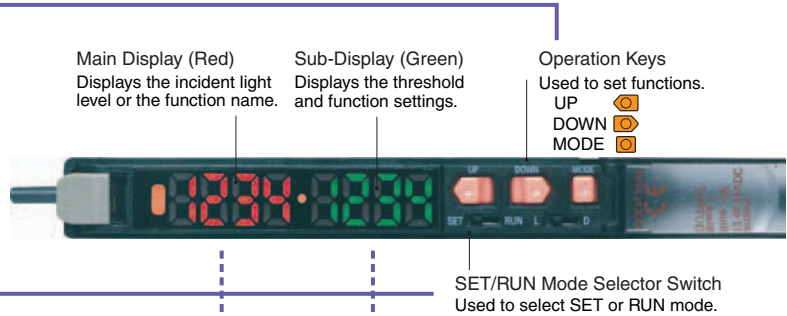

SET/RUN mode	Operation keys	Operation	Displays		Remarks
			Main display	Sub-display	
Detection/adjustment RUN (Factory-set to RUN)	/	Adjusting thresholds	Incident level	Threshold	→Page 12 Refer to 4. <i>Setting Thresholds Manually in RUN Mode.</i> Used to execute various teaching and zero-reset operations →Page 12 Refer to 3. <i>Registering Workpiece Colors with Teaching in SET Mode.</i>
		Executing user-specified functions (factory-set to 1-point teaching)			
Function settings SET	/	Teaching and changing setting details	Setting items	Setting details	→Page 12 Refer to 3. <i>Registering Workpiece Colors with Teaching in SET Mode.</i> →Page 13 Refer to 5. <i>Setting Functions in SET Mode.</i>
		Switching setting items	 	 	

SET/RUN mode	Operation keys	Operation	Displays		Remarks
			Main display	Sub-display	
RUN (Factory-set to RUN)	+	Locking and unlocking keys	LOC 	ON 	Locks key operation to prevent incorrect operation. →Page 14 Refer to 6. <i>Convenient Functions.</i>
SET	+	Initialization and user reset	INIT 	YES? 	Returns the system to its default settings. →Page 14 Refer to 6. <i>Convenient Functions.</i>

1 Changing Banks (for Advanced Models (4-color Determination))

The bank where data is registered can be changed by using the bank input and the channel switch.

Bank	A	B	C	D
Bank input	Open	Open	Closed	Closed
Channel switch	1 <input type="checkbox"/> 2	1 <input type="checkbox"/> 2	1 <input type="checkbox"/> 2	1 <input type="checkbox"/> 2
Display	1000 • 8900	1000 • 6900	1000 • 2900	1000 • 8900

2 Setting the Operation Mode

The operation mode is set with the Mode Selector Switch.

Operation mode	Operation
ON when matching	L-ON <input type="checkbox"/> (Factory-set)
ON when not matching	D-ON <input type="checkbox"/> D

*The operation mode is set in SET mode.
 → Refer to 5. Setting Functions in SET Mode on page 13.

*Advanced Models (Same for All Adjustments): Set the Channel Selector Switch to the desired channel before making any adjustments or settings.

3 Registering Workpiece Colors with Teaching in SET Mode

*Workpiece colors must always be taught to perform judgment for registered workpieces.
 *With the factory settings, 1-point teaching can be executed in RUN mode. (Press the MODE Key for 3 s.)

3-1. One-point Teaching

Along with registering the workpiece colors, the threshold can be set to a level of approximately 10% of the degree of matching.
 The setting is completed in a simple operation with one press of a button.

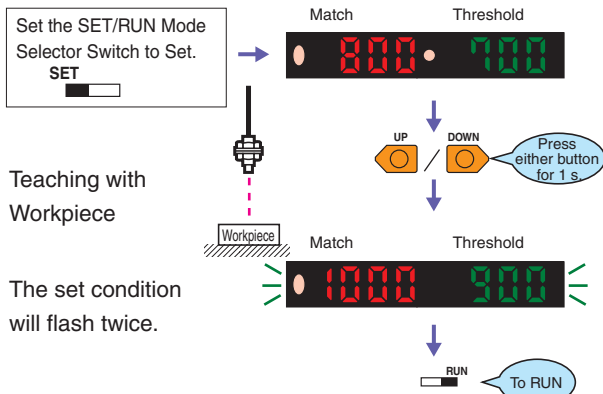

*The threshold level can change in SET mode if the teaching level function is used.
 *If BLACK mode is selected as the judgment mode in SET mode, the threshold will be set to a level of approximately 10% higher than the displayed degree of matching.

3-2. Teaching with and without a Workpiece

Two points, with and without the workpiece, are detected, and the match of the intermediate point is set as the threshold.

This method is ideal for setting thresholds with margins or performing judgments with low match.

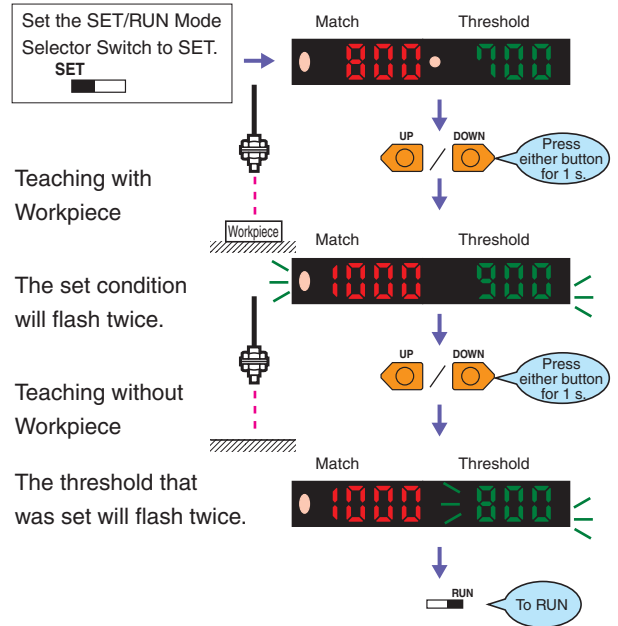

*When teaching is performed, position the workpiece by using the OVER, OK, and LO messages displayed on the sub-display (green) as guides.

TEch • oVEr	OVER: Move the workpiece away.
TEch • oK	OK: Teaching is possible.
TEch • Lo	LO: Move the workpiece closer.

4 Setting Thresholds Manually in RUN Mode

A threshold can be set manually. A threshold can also be adjusted manually after teaching to fine-tune it.

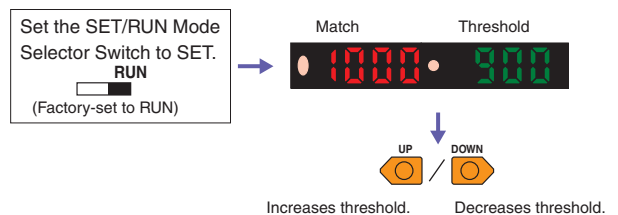

*Even if the display method is changed, the threshold will appear on the sub-display when the key is pressed.

5 Setting Functions in SET Mode

Moving between Functions

→ Refer to 3. Registering Workpiece Colors with Teaching in SET Mode on page 12.

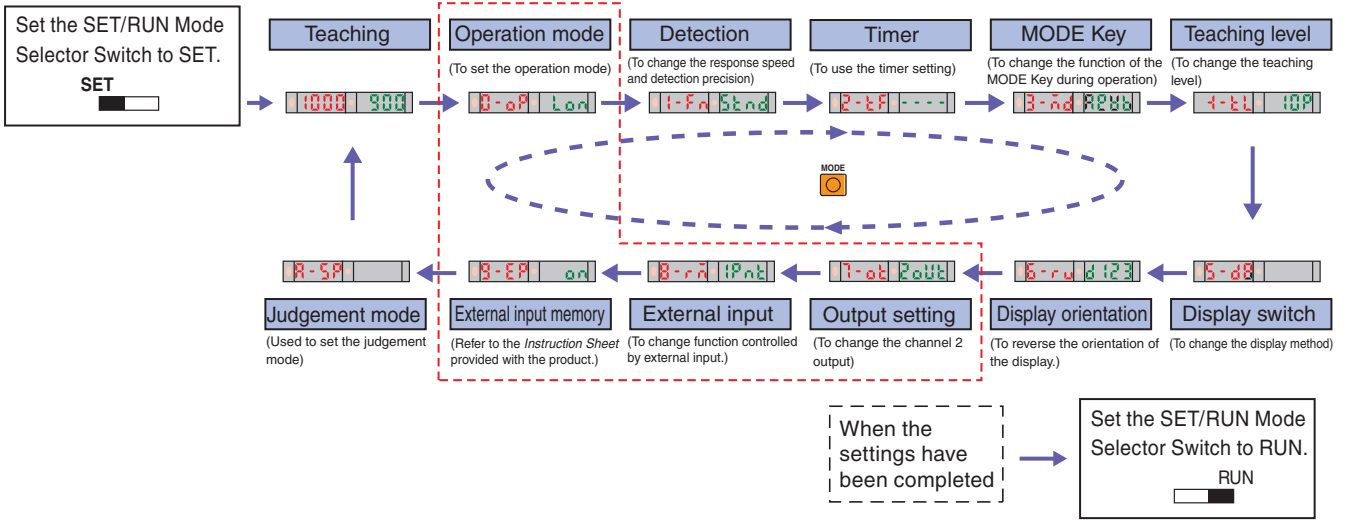

*The function transition boxes show the default settings.
 *More functions may be displayed depending on the detailed settings.
 *The items enclosed by dotted red lines are for advanced models only.
 (Advanced models with four-color determination do not have External input or External input memory.)

Functions

UP / DOWN Use the UP and DOWN Keys to change the settings.

Function	Setting (display)	Description
Operation mode	ON when matching: Lōn , ON when not matching: dōn	→ Refer to 2. Setting the Operation Mode on page 12.
Detection	Super-high-speed: SHS , High-speed: HS , Standard: Stnd , High-precision: HrES Note: If the detection function is changed, be sure to register (i.e., teach) the workpiece color.	Used to change the response speed and detection precision. Note: The fastest mode is I mode (light intensity determination for red, green, or blue)
Timer	Timer disabled: --- , OFF-delay timer: oFFd , ON-delay timer: on-d , One-shot timer: 1Shk	Used to set a timer for the control output.
Time (timer enabled)	1 to 5000 ms: 1 to 5000 1 to 20 ms: 1-ms increments, 20 to 200 ms: 5-ms increments, 200 ms to 1 s: 100-ms increments, 1 to 5 s: 1-s increments	Used to change the timer setting. Setting range: 1 ms to 5 s
MODE Key	One-point teaching: 1Pnt , With/without workpiece teaching: 2Pnt , Executes a zero reset: 0rSt (→ Refer to 6.1 on page 14.)	Used to change the function of the MODE Key during operation.
Teaching level	0 to 99%: 0 to 99	Used to set the teaching level for the threshold when performing 1-point teaching. (Example: The threshold level at the default setting (10) is 900.) (When the setting is 20, the threshold level is 800.)
Display switch	1. Match/Threshold: 850 • 500 2. Excess gain/Threshold: 0P 123 • 500 3. Peak/Bottom refreshed every 2 s: 0PERM • 0000 4. Peak/Bottom refreshed every time the output is switched: 0L-PE • 0-00 5. Analog bar display: 0 • 0000 6. Match/Peak refreshed at a set interval: 0 • 850 • 0PERM 7. Match/Channel: 0 • 850 • 2ch	1. Used to display the degree of matching and threshold. 2. Used to display the excess gain (i.e., percentage of matching relative to threshold) and threshold. 3. Used to display the peak and bottom degrees of matching at a fixed interval. 4. Used to display the peak degree of matching when there is a match and the bottom degree of matching when there is no match. 5. Used to show the detection status with a bar display. Red bars will be displayed if the degree of match exceeds the threshold. 6. Used to display the present incident level and the peak degree of matching. 7. Used to display the degree of matching and channel number.
Display orientation	Normal display: d 123 , Up/down reversed display: E 21 P	Used to reverse the orientation of the display.
Output setting	Each channel: 2ōūt , AND: And , OR: ōr	Used to change the item output on control output 2.
Timer	Timer disabled: --- , OFF-delay timer: oFFd , ON-delay timer: on-d , One-shot timer: 1Shk	Used to set timers for the AND/OR control output.
Time	1 to 5000 ms: 1 to 5000 1 to 20 ms: 1-ms increments, 20 to 200 ms: 5-ms increments, 200 ms to 1 s: 100-ms increments, 1 to 5 s: 1-s increments	Used to change the timer setting. Setting range: 1 ms to 5 s
External input	One-point teaching: 1Pnt , With/without workpiece teaching: 2Pnt , Executes a zero reset: 0rSt , Light OFF: LōFF	Used to change function controlled by external input. Refer to the Instruction Sheet provided with the product for information on the effective pulse width.
External input memory	Write results to EEPROM: on , Don't write results: oFF	Used to set writing the results. (Refer to the Instruction Sheet provided with the product.)
Judgment mode	C/I automatic judgment: Ryūō , C mode: c , I mode: I , BLACK mode: blP	Used to set the judgment mode (detection method). BLACK mode: The total light intensity for RGB is used for the judgment.

6 Convenient Functions

6-1. Zeroing the Digital Display (Zero Reset)

The incident light level displayed on the main display can be reset to 0. This is useful when the reference display is to be reset to zero because the match display and the threshold are shifted at the same time.

*Change the function to 0RST (zero reset) with the MODE Key. The default setting is PTUN.
The default setting is 1PNT.
→Refer to 5. Setting Functions in SET Mode on page 13.



To return to original value for incident light level:

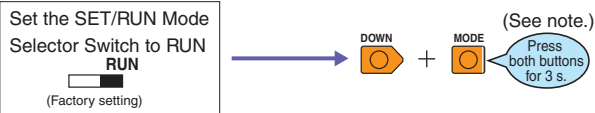

Note: Press the DOWN Key right after pressing the MODE Key.

6-2. Locking the Keys (Key Lock)

All key operations can be disabled.

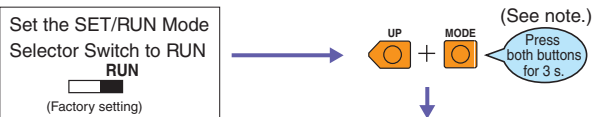

"ON" will flash twice and key operations will be disabled.



To release the lock:

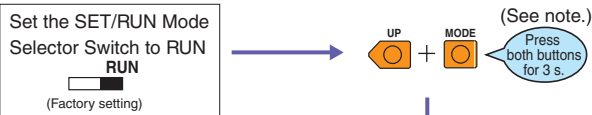

"OFF" will flash twice and key operations will be enabled.



*If a key is pressed while key operations are locked, "LOC" will flash twice on the display to indicate that key operations have been disabled.

Note: Press the UP Key right after pressing the MODE Key.

6-3. Saving a Set State (Saving User Settings)

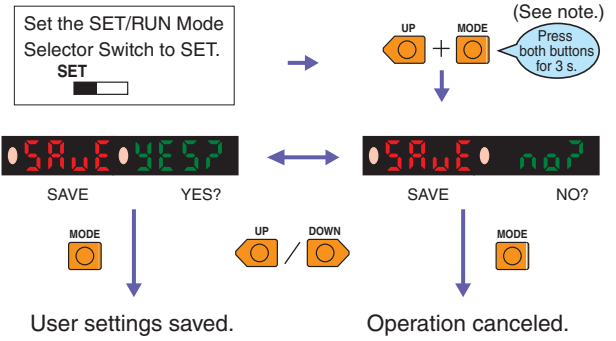

Note: Be sure to register (i.e., teach) the workpiece colors if the detection functions have been changed.

6-4. Initializing Settings (Initialization and User Reset)

All settings can be returned to their original default settings.

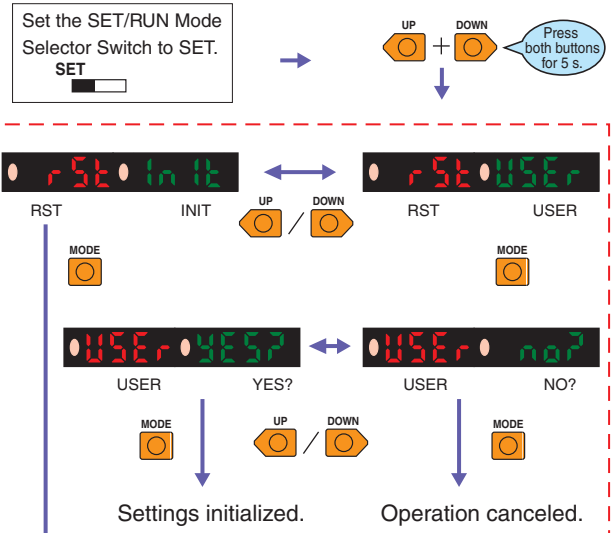

(The section enclosed by dotted lines applies to user-saved settings.)

