

Ultracompact, Ultrathin Photoelectric Sensors with Built-in Amplifiers

E3T Series



The Improved E3T Series

Makes Mounting and Installation Simpler and Smoother

Suitable for Applications in the Rechargeable Battery Industry

Small Cylindrical Sensors

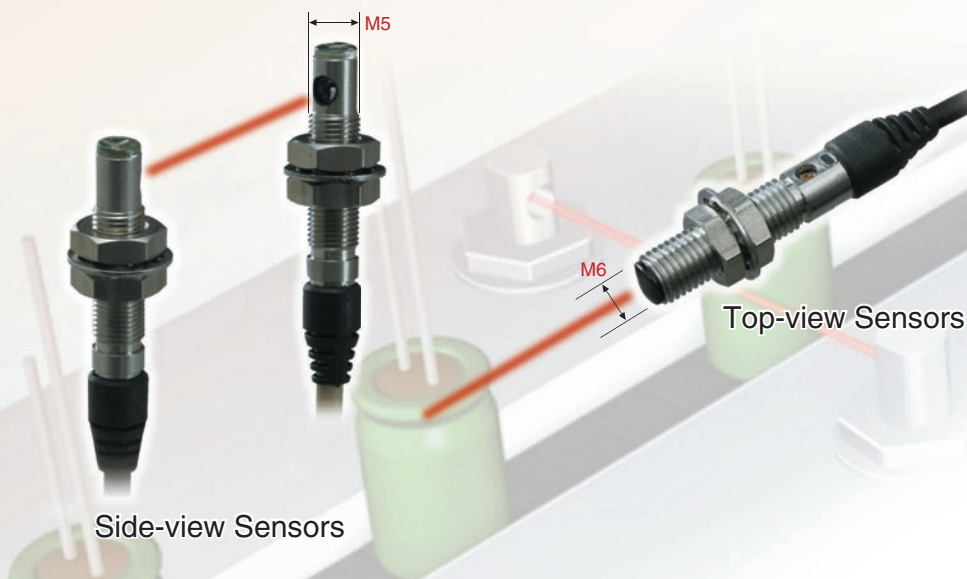

M3-mounting Sensors

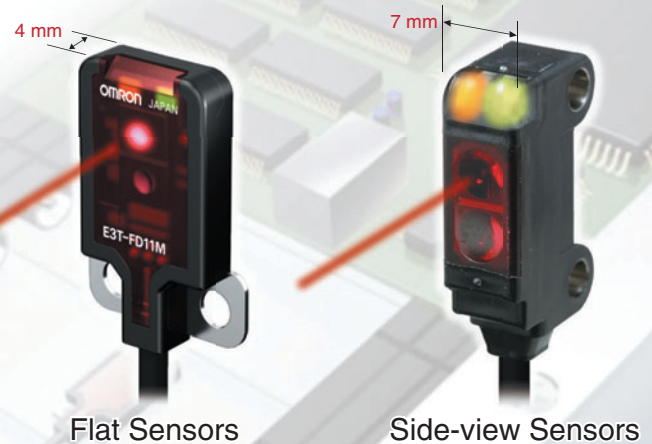

Simple, Low-cost Installation, Setup, and Operation

New Small Cylindrical Sensors

With Square Sensors:

- Time is required to tighten screws.
- Mounting brackets are sometimes required.

But with Small Cylindrical Sensors:

Less Drilling and Tightening Work.

Work is reduced because holes do not need to be threaded and there is only one place to tighten.

AND

Mounting without Brackets.

For Through-beam Sensors, both Top-view and Side-view Models are available. Select the shape according to installation conditions to mount directly to the system without brackets.

Square Sensor
Threaded holes are required in two locations.

Side-view Sensor Mounted to Horizontal Surface

Top-view Sensor Mounted to Vertical Surface

Drilling and tightening are required in only one location. Brackets are not required and cable routing is simplified.

Sure Installation without Stress

Side-view and Flat Sensor Models for M3 Mounting

With Previous M3-mounting Sensors:

- Sensor heads were large.

With Previous M2-mounting Sensors:

- The small screws were hard to handle.

With M3-mounting Sensors:

Compact M3 Mounting.
Essentially the Same Size as M2-mounting Sensors.

The width and depth are essentially the same as previous M2-mounting sensors. Easier application without increasing space requirements.

AND

Secure Tightening and Mounting.
Stainless-steel Mounting Plates or Sleeves

Side-view Sensors mount with SUS304 sleeves, while Flat Sensors mount with SUS304 plates. The reliable strength provide sure tightening that will not come loose. Damage from overtightening is also prevented for sure mounting.

20 mm → More compact → 4 mm

← 3.5 mm ← Installation work

Previous M3-mounting Sensors **NEW** Flat, M3-mounting Sensors Flat, M2-mounting Sensors

Easier to handle

The flat sensing surface is maintained even with larger screws.

The screw heads do not protrude.

Previous Sensors Stainless-steel plate M3-mounting Sensors

Small Cylindrical Sensors

With Fiber Sensors:

- **Installation** Space is required for the Amplifier.
- **Setup** Setup and installation are troublesome.
- **Operation** Initial and electrical costs are high.

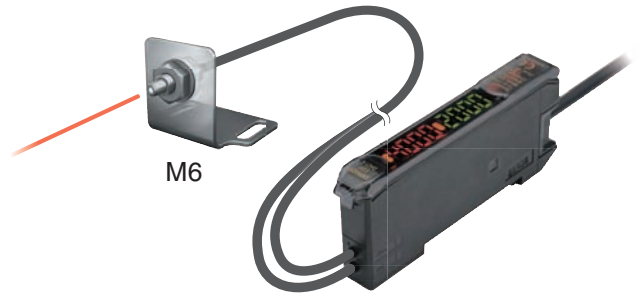

But with Small Cylindrical Sensors:

**Essentially the Same Size as the Fiber Head.
But No Amplifier Is Required.**

Mounting is possible in narrow spaces where only fiber sensors could previously be used. The built-in amplifier and teach-free operation reduce wiring and setup work. And initial costs and electrical costs are also reduced.

Diffuse-reflective Sensors
(with Sensitivity Adjuster)

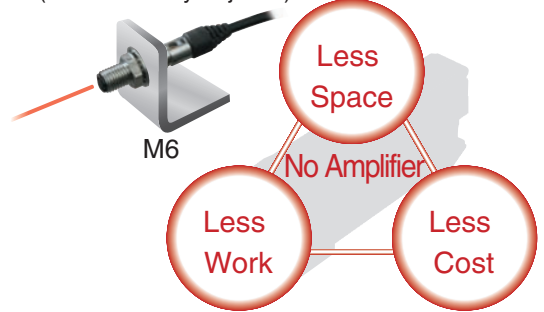

Overall Features

Many Compact Shapes for Various Applications

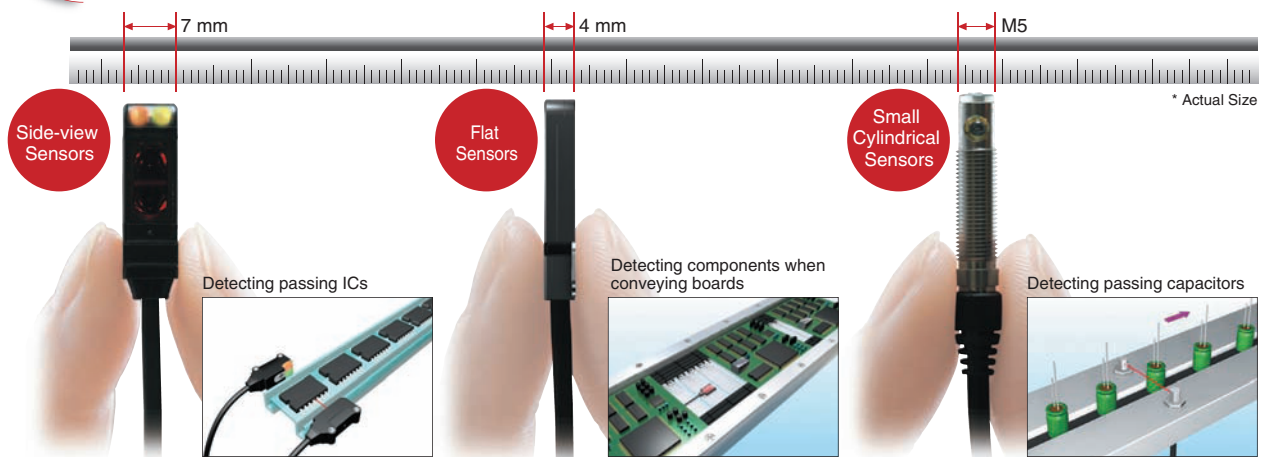

Ideal for Rechargeable Battery Manufacturing Lines

All Metal Parts Are Stainless Steel. No Worries About Conductive Copper Intrusion.

The case, nuts, and washers of the Cylindrical Sensors are all stainless steel, as are the mounting plates and sleeves of the M3-mounting Sensors. Harmful copper, zinc, and nickel plating are not used, enabling reliable application in rechargeable battery manufacturing lines. Stainless-steel screws are also available, for immediate application for rechargeable batteries.



Ordering Information

Small Cylindrical Sensors

| Sensing method | Appearance | Connection method | Sensing distance | Operation mode | Model | |
|------------------------------------|------------|-------------------|------------------|----------------|--------------|--------------|
| | | | | | NPN output | PNP output |
| Through-beam | | Pre-wired (2 m) | 1 m | Dark-ON | E3T-CT12 2M | E3T-CT14 2M |
| | | | 500 mm | Dark-ON | E3T-CT22S 2M | E3T-CT24S 2M |
| Diffuse-reflective (with adjuster) | | | 3 to 50 mm | Light-ON | E3T-CD11 2M | E3T-CD13 2M |

Dimensions (Unit: mm)

Top-view Through-beam Sensors

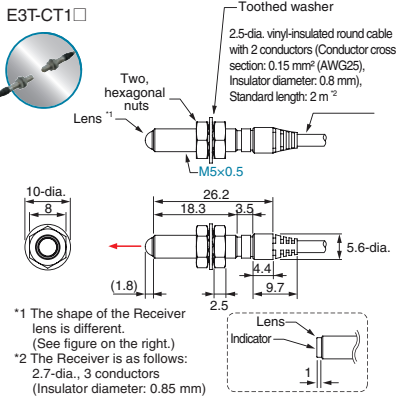

Side-view Through-beam Sensors

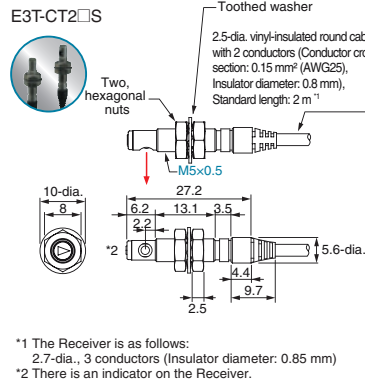

Top-view Diffuse-reflective Sensors

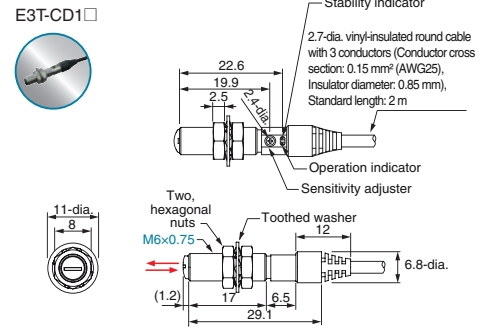

* Recommended Mounting Hole: M5 Through-beam Sensors: 5.5^{+0.5}₀, M6 Diffuse-reflective Sensors: 6.5^{+0.5}₀

M3-mounting Sensors

| Sensing method | Appearance | Connection method | Sensing distance | Operation mode | Model | |
|-----------------------|------------|-------------------|------------------|----------------|--------------|--------------|
| | | | | | NPN output | PNP output |
| Through-beam *1 *2 | | Pre-wired (2 m) | 1 m | Light-ON | E3T-ST11M 2M | E3T-ST13M 2M |
| | | | 300 mm | Dark-ON | E3T-ST12M 2M | E3T-ST14M 2M |
| | | | 5 to 30 mm | Light-ON | E3T-ST21M 2M | E3T-ST23M 2M |
| | | | | Dark-ON | E3T-ST22M 2M | E3T-ST24M 2M |
| Diffuse-reflective | | Pre-wired (2 m) | 5 to 30 mm | Light-ON | E3T-FD11M 2M | E3T-FD13M 2M |
| | | | | Dark-ON | E3T-FD12M 2M | E3T-FD14M 2M |
| Convergent-reflective | | Pre-wired (2 m) | 5 to 15 mm | Light-ON | E3T-SL11M 2M | E3T-SL13M 2M |
| | | | | Dark-ON | E3T-SL12M 2M | E3T-SL14M 2M |
| | | | | Light-ON | E3T-SL21M 2M | E3T-SL23M 2M |
| | | | | Dark-ON | E3T-SL22M 2M | E3T-SL24M 2M |

*1. The model number of the Emitter is expressed by adding an "L" to the set model number in the table. Example: E3T-ST11-L 2M
The model number of the Receiver is expressed by adding a "D" to the set model number in the table. Example: E3T-ST11-D 2M
Orders for individual Emitters and Receivers are accepted. (Modifications are required for some models.)

*2. Infra-red models are also available. For details, refer to your OMRON website.

Dimensions (Unit: mm)

Side-view Through-beam Sensors

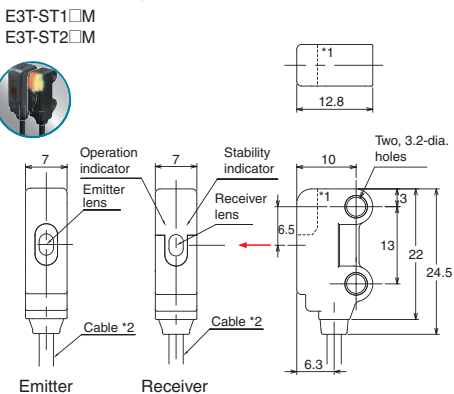

Flat Diffuse-reflective Sensors

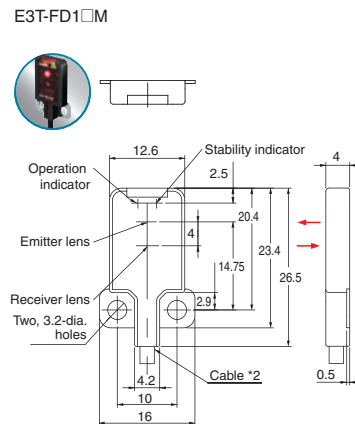

Side-view Convergent-reflective Sensors

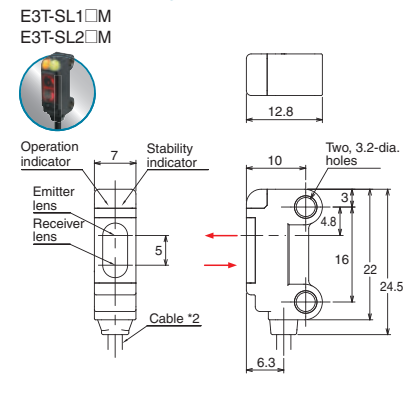

*1. The dotted line indicates the Receiver.

*2. 4-dia. vinyl-insulated round cable with 2 or 3 conductors (Conductor cross section: 0.1 mm² (AWG27), Insulator diameter: 0.7 mm), Standard length: 2 m
For Through-beam Sensors, the Emitter has two conductors and the Receiver has three conductors. Diffuse-reflective Sensors and Convergent-reflective Sensors have three conductors.

Accessories

These accessories are not included with the Sensor. Order them separately if required.

| Name | | Applicable Sensor | Model | Quantity | Remarks |
|---|----------|-------------------|----------|--|---|
| Slits for Through-beam Side-view Sensors | 0.5 dia. | E3T-ST1□M | E39-S76A | One each for Emitter and Receiver (2) | Sensing distance 100 mm |
| | 1 dia. | | E39-S76B | | Sensing distance 300 mm |
| M3 Mounting Bracket for Side-view Sensors * | | E3T-S□□□M | E39-L166 | 1 | Nut plate provided |
| M3 Mounting Bracket for Flat Sensors | | E3T-FD□□M | E39-L167 | | --- |
| M3 Back-mounting Spacer for Flat Sensors | | E3T-FD□□M | E39-L168 | 1 | Use this Spacer when mounting a Sensor from the back. |
| M3 SUS304 Screw Set for Flat Sensors | | E3T-FD□□M | E39-L170 | Two bolts with hexagonal hole (M3x6) | --- |
| M3 SUS304 Screw Set for Side-view Sensors * | | E3T-S□□□M | E39-L171 | Two each of the following: Bolt with hexagonal hole (M3x15), Hexagonal nuts, Spring washers, Flat washers | --- |
| M2 SUS304 Screw Set for Flat Sensors * | | E3T-F□□□ | E39-L172 | Two bolts with hexagonal hole (M2x6) | The screw set that is provided with the Sensor is zinc-plated steel. Use this SUS Screw Set when stainless steel is required. |
| M2 SUS304 Screw Set for Side-view Sensors * | | E3T-S□□□ | E39-L173 | Two each of the following: Bolt with hexagonal hole (M2x12), Hexagonal nuts, Spring washers, Flat washers | |

* For a Through-beam Sensor, order one Bracket or Screw Set for the Emitter and one for the Receiver.

Ratings and Specifications

| Sensing method | | Through-beam | | | | Diffuse-reflective | | Convergent-reflective | |
|-------------------------------------|----------------|---|-----------|--|------------------------|---|--|--|--|
| Appearance | | Side-view | | Cylindrical type | | Cylindrical type | Flat | Side-view | |
| | | | | Top-view | Side-view | Top-view | | | |
| NPN | Light-ON | E3T-ST11M | E3T-ST21M | --- | --- | E3T-CD11 | E3T-FD11M | E3T-SL11M | E3T-SL21M |
| | Dark-ON | E3T-ST12M | E3T-ST22M | E3T-CT12 | E3T-CT22S | --- | E3T-FD12M | E3T-SL12M | E3T-SL22M |
| PNP | Light-ON | E3T-ST13M | E3T-ST23M | --- | --- | E3T-CD13 | E3T-FD13M | E3T-SL13M | E3T-SL23M |
| | Dark-ON | E3T-ST14M | E3T-ST24M | E3T-CT14 | E3T-CT24S | --- | E3T-FD14M | E3T-SL14M | E3T-SL24M |
| Sensing distance | | 1 m | 300 mm | 1 m | 500 mm | 3 to 50 mm (100 × 100 mm white paper) | 5 to 30 mm (50 × 50 mm white paper) | 5 to 15 mm (50 × 50 mm white paper) | 5 to 30 mm (50 × 50 mm white paper) |
| Standard sensing object | | Opaque, 2-mm dia. min. | | Opaque, 4-mm dia. min. | Opaque, 5-mm dia. min. | --- | | | |
| Minimum detectable object (typical) | | Opaque, 2-mm dia. | | --- | | --- | 0.15-mm dia. (sensing distance 10 mm) | | |
| Hysteresis (white paper) | | --- | | | | 15% or less of the sensing distance | 6 mm max. | 2 mm max. | 6 mm max. |
| Directional angle | | Emitter: 2 to 20°, Receiver: 2 to 70° | | Receiver: 2° | Receiver: 10° | --- | | | |
| Light source (wavelength) | | Red LED (650 nm) | | Red LED (630 nm) | Red LED (625 nm) | Infrared LED (870 nm) | Red LED (650 nm) | | |
| Power supply voltage | | 12 to 24 VDC ±10%, ripple (p-p) 10% max. | | | | | | | |
| Current consumption | | 30 mA max. (Emitter: 10 mA max., Receiver: 20 mA max.) | | 30 mA max. (Emitter: 15 mA max., Receiver: 15 mA max.) | | 20 mA max. | | | |
| Control output | | Load power supply voltage: 26.4 VDC max. Load current: 50 mA max. (residual voltage: 2 V max. for load current of 10 to 50 mA, 1 V max. for load current of less than 10 mA), Open-collector output | | Load power supply voltage: 30 VDC max. Load current: 80 mA max. (residual voltage: 1 V max.) Open-collector output | | Load power supply voltage: 26.4 VDC max. Load current: 50 mA max. (residual voltage: 2 V max. for load current of 10 to 50 mA, 1 V max. for load current of less than 10 mA), Open-collector output | | | |
| Protection circuits | | Power supply and control output reverse polarity protection Output short-circuit protection | | Power supply reverse polarity protection Output short-circuit protection | | Power supply and control output reverse polarity protection Output short-circuit protection Mutual interference prevention | | | |
| Response time | | Operate or reset: 1 ms max. | | Operate or reset: 0.5 ms max. | | Operate or reset: 1 ms max. | | | |
| Ambient illumination | | Incandescent lamp: 5,000 lx max. | | Incandescent lamp: 3,000 lx max. | | Incandescent lamp: 5,000 lx max. | | | |
| Ambient temperature range | | Operating: -25 to +55°C Storage: -40 to +70°C (with no icing or condensation) | | Operating: -25 to +55°C Storage: -30 to +70°C (with no icing or condensation) | | Operating: -25 to +55°C Storage: -40 to +70°C (with no icing or condensation) | | | |
| Ambient humidity range | | Operating: 35% to 85% Storage: 35% to 95% (with no condensation) | | Operating or Storage: 35% to 85% (with no condensation) | | Operating: 35% to 85% Storage: 35% to 95% (with no condensation) | | | |
| Insulation resistance | | 20 MΩ min. at 500 VDC | | | | | | | |
| Dielectric strength | | 1,000 VAC, 50/60 Hz for 1 min. | | 500 VAC, 50/60 Hz for 1 min. | | 1,000 VAC, 50/60 Hz for 1 min. | | | |
| Vibration resistance (destruction) | | 10 to 2,000 Hz, 1.5-mm double amplitude or 300 m/s ² for 0.5 hours each in X, Y, and Z directions | | 10 to 55 Hz, 1.5-mm double amplitude for 2 hours each in X, Y, and Z directions | | 10 to 2,000 Hz, 1.5-mm double amplitude or 300 m/s ² for 0.5 hours each in X, Y, and Z directions | | | |
| Shock resistance (destruction) | | 1,000 m/s ² 3 times each in X, Y, and Z directions | | 500 m/s ² 3 times each in X, Y, and Z directions | | 1,000 m/s ² 3 times each in X, Y, and Z directions | | | |
| Degree of protection | | IP67 (IEC 60529) | | IP65 (IEC 60529) | | IP67 (IEC 60529) | | | |
| Connection method | | Pre-wired (standard length: 2 m) | | | | | | | |
| Weight | | Approx. 40 g | | Approx. 60 g | | Approx. 40 g | | Approx. 20 g | |
| Materials | Case | PBT (polybutylene terephthalate) | | SUS303 | | PBT (polybutylene terephthalate) | | | |
| | Display window | Denatured polyarylate | | Polysulfone | | Epoxy | | Denatured polyarylate | |
| | Lens | Denatured polyarylate | | Polysulfone | | | | Denatured polyarylate | |
| Accessories | | Instruction manual ^{*1} | | Instruction manual Hexagonal nuts ^{*3} Toothed washers ^{*3} | | Instruction manual Hexagonal nuts ^{*4} Toothed washers ^{*4} Adjustment driver ^{*5} | | Instruction manual ^{*1} | |

*1 Order the E39-L171 Screw Set separately if required.

*2 Order the E39-L170 Screw Set separately if required.

*3 A E39-M5 SUS Nut Set is included with the Sensor, but it can also be ordered separately.

*4 A E39-M6 SUS Nut Set is included with the Sensor, but it can also be ordered separately.

*5 A E39-G17 Adjustment Driver is included with the Sensor, but it can also be ordered separately.

■ Ordering Information

E3T-series Sensors, M2-mounting Sensors

Red light

| Sensing method | Appearance | Connection method | Sensing distance | Operation mode | Model | | |
|--|------------|-------------------|---|----------------|----------------|----------------|-------------|
| | | | | | NPN output | PNP output | |
| Through-beam (Emitter + Receiver) *1 *2 | | Pre-wired (2 m) | 1 m (Sensitivity Adjustment Unit can be used.) | Light-ON | E3T-ST11 2M | E3T-ST13 2M | |
| | | | | Dark-ON | E3T-ST12 2M | E3T-ST14 2M | |
| | | | 300 mm | Light-ON | E3T-ST21 2M | E3T-ST23 2M | |
| | | | | Dark-ON | E3T-ST22 2M | E3T-ST24 2M | |
| | | | 500 mm | Light-ON | E3T-FT11 2M | E3T-FT13 2M | |
| | | | | Dark-ON | E3T-FT12 2M | E3T-FT14 2M | |
| | | | 300 mm | Light-ON | E3T-FT21 2M | E3T-FT23 2M | |
| | | | | Dark-ON | E3T-FT22 2M | E3T-FT24 2M | |
| Retro-reflective | | Pre-wired (2 m) | Using the E39-R4 Reflector provided 200 mm [30 mm] *3 | Light-ON | E3T-SR41 2M *3 | E3T-SR43 2M *4 | |
| | | | | Dark-ON | E3T-SR42 2M *3 | E3T-SR44 2M *4 | |
| Using the E39-R37-CA 100 mm [10 mm] *3 | Light-ON | | E3T-SR41 2M *3 | E3T-SR43 2M *4 | | | |
| | Dark-ON | | E3T-SR42 2M *3 | E3T-SR44 2M *4 | | | |
| Diffuse-reflective | | | Pre-wired (2 m) | 5 to 30 mm | Light-ON | E3T-FD11 2M | E3T-FD13 2M |
| | | | | | Dark-ON | E3T-FD12 2M | E3T-FD14 2M |
| Convergent-reflective | | | | 5 to 15 mm | Light-ON | E3T-SL11 2M | E3T-SL13 2M |
| | | | | | Dark-ON | E3T-SL12 2M | E3T-SL14 2M |
| | | 5 to 30 mm | | Light-ON | E3T-SL21 2M | E3T-SL23 2M | |
| | | | | Dark-ON | E3T-SL22 2M | E3T-SL24 2M | |
| BGS-reflective | | 1 to 15 mm | | Light-ON | E3T-FL11 2M | E3T-FL13 2M | |
| | | | | Dark-ON | E3T-FL12 2M | E3T-FL14 2M | |
| | | 1 to 30 mm | Light-ON | E3T-FL21 2M | E3T-FL23 2M | | |
| | | | Dark-ON | E3T-FL22 2M | E3T-FL24 2M | | |

*1. The model number of the Emitter is expressed by adding an "L" to the set model number in the table. Example: E3T-ST11-L 2M
The model number of the Receiver is expressed by adding a "D" to the set model number in the table. Example: E3T-ST11-D 2M
Orders for individual Emitters and Receivers are accepted. (Modifications are required for some models.)

*2. Infra-red models are also available. For details, refer to your OMRON website.

*3. Values in parentheses indicate the minimum required distance between the Sensor and Reflector.

*4. Models are available either with or without the E39-R37-CA Reflector included.
Models with E39-R37-CA Reflector. E3T-SR4□-S Models without Reflector. E3T-SR4□-C

Note: The mounting holes on M2-mounting Sensors are SUS301 stainless steel.

OMRON Corporation Industrial Automation Company
Tokyo, JAPAN

Contact: www.ia.omron.com

Regional Headquarters

OMRON EUROPE B.V.
Sensor Business Unit
Carl-Benz-Str. 4, D-71154 Nufringen, Germany
Tel: (49) 7032-811-0/Fax: (49) 7032-811-199

OMRON ASIA PACIFIC PTE. LTD.
No. 438A Alexandra Road # 05-05/08 (Lobby 2),
Alexandra Technopark,
Singapore 119967
Tel: (65) 6835-3011/Fax: (65) 6835-2711

OMRON ELECTRONICS LLC
One Commerce Drive Schaumburg,
IL 60173-5302 U.S.A.
Tel: (1) 847-843-7900/Fax: (1) 847-843-7787

OMRON (CHINA) CO., LTD.
Room 2211, Bank of China Tower,
200 Yin Cheng Zhong Road,
PuDong New Area, Shanghai, 200120, China
Tel: (86) 21-5037-2222/Fax: (86) 21-5037-2200

Authorized Distributor:

© OMRON Corporation 2011 All Rights Reserved.
In the interest of product improvement,
specifications are subject to change without notice.

CSM_4_1_0514
Cat. No. E408-E1-01

Printed in Japan
(0211)